

Cobalt Series

9 GHz



- **Frequency range:** 100 kHz - 9 GHz
- **Wide output power range:** -60 dBm to +15 dBm
- **Dynamic range:** 162 dB (1 Hz IF bandwidth) typ.
- **Measurement time per point:** 10 μ s per point, min typ.
- **16 logical channels with 16 traces** each max
- **Automation programming** in LabView, Python, MATLAB, .NET, etc.
- 2- and 4-port models with **Direct Receiver Access** and **Frequency Extension** as available options
- **Time domain and gating** conversion included
- **Fixture simulation**
- **Frequency offset mode**, including vector mixer calibration measurements
- Up to **500,001 measurement points**
- Multiple **precision calibration** methods and automatic calibration

EXTEND YOUR REACH

Industry-leading dynamic range and sweep speed



The Cobalt 9 GHz Product Series of high-performance vector network analyzers offers an unmatched price-performance combination for S-parameter measurement between 100 kHz and 9 GHz and incorporates multiple technological innovations.

Advanced electromagnetic modeling was used to optimize the 9 GHz Cobalt's ultra-wideband directional coupler design. Because we incorporated new production methods for precision, these directional couplers have extraordinary stability, both over temperature and over very long intervals of time. Cobalt's hybrid dual-core DSP+FPGA signal processing engine, combined with new frequency synthesizer technologies, propel Cobalt's measurement speed to among the most advanced instruments in the industry, and well past the achievements of any cost-competitive products.

Copper Mountain Technologies' USB VNAs are next generation analyzers designed to meet the needs of 21st Century engineers. Our VNAs include an RF measurement module and a processing module, a software application which runs on a Windows PC, laptop or tablet, connecting to the measurement hardware via USB interface.

This innovative approach delivers high measurement accuracy and enables users to take advantage of faster processors, newer computers and larger displays. USB VNAs have lower Total Cost of Ownership and fewer potential failure points.

These instruments are smaller and lighter, can go almost anywhere, are very easy to share and eliminate the need for data purging or hard drive removal in secure environments.

The Whole Solution

Warranty, Service, & Repairs

All our products come with a standard three-year warranty from date of shipment. During that time we will repair or replace any product malfunctioning due to defective parts or labor.

While we pride ourselves on quality of our instruments, should your VNA malfunction for any reason, we will gladly offer a loaner unit while we service yours. With our USB VNAs where all data is stored on your PC, a simple swap of the measurement module assures uninterrupted workflow and little or no downtime.

Our engineers are an extension of your team

Our team of applications engineers, service technicians, and metrology scientists are here to help you with technical support, application-specific recommendations, annual performance testing, and troubleshooting or repair of your CMT instruments.

Our engineers will work with your team to augment your in-house capabilities. We can write custom applications and test software, develop test automation scripts and help with integrated RF system testing. We can design and provide an RF switching network specific to your requirements; electro-mechanical, solid-state, or PIN diode-based. If the S-parameter measurement fixture involves challenging conditions for repeatability and accuracy we can assist with measurement uncertainty analysis.

An extensive library of technical materials including application notes, tips on performing VNA measurements, sample automation scripts, and how-to videos are available on our website www.coppermountaintech.com and YouTube channel, CopperMountainTech.

Annual Calibration

Copper Mountain Technologies' Indianapolis calibration laboratory is accredited in accordance with the recognized international standard ISO/IEC 17025 (2005) and meets the requirements of ANSI/NCSL Z540-1994-1. All reference standards and equipment in the laboratory are traceable to National Institute of Standards and Technology (NIST) or international equivalent.

Should you prefer to perform the annual testing yourself or use a third party, contact us for information or questions on performing these procedures. Additionally, the VNA Performance Test (VNAPT) software application is available for third party laboratories without restriction. Use of VNAPT to execute performance tests is optional, but the software is designed to automate and streamline VNA performance testing, including automatic generation of test reports. Please contact Copper Mountain Technologies or your local distributor for recommended calibration options.

"The small size and low weight of CMT's VNAs are also advantageous for applications in the manufacturing industries. For example, applications such as base transceiver station (BTS) filter tuning or semiconductor manufacturing require a wide dynamic range and fast speed. CMT's C1209 and C1220 are ideal instruments for these applications because they not only address the performance requirements of the applications but their form factor also enables them to be put on top of the handlers rather than being put on the side, where they take up space. As a result, customers are able to put more handlers in a room, increasing throughput. With CMT's VNAs, customers also get the additional benefit of instantaneous data transfer as the VNA and the handler are in the same operating system (OS)."

Jessy Cavazos
Industry Director, Frost & Sullivan

Software Application

Software application is part of the VNA

The software application takes raw measurement data from the data acquisition (measurement) module and recalculates into S-parameters in multiple presentation formats utilizing proprietary algorithms. These new and advanced calibration and other accuracy enhancing algorithms were developed by our metrology experts. Our software can be downloaded free from our website, used on an unlimited number of PCs, and enables easy VNA integration with other software applications and automation.

The software application features a fully functioning Demo Mode, which can be used for exploring the VNAs' features and capabilities without an actual measurement module connected to your PC.

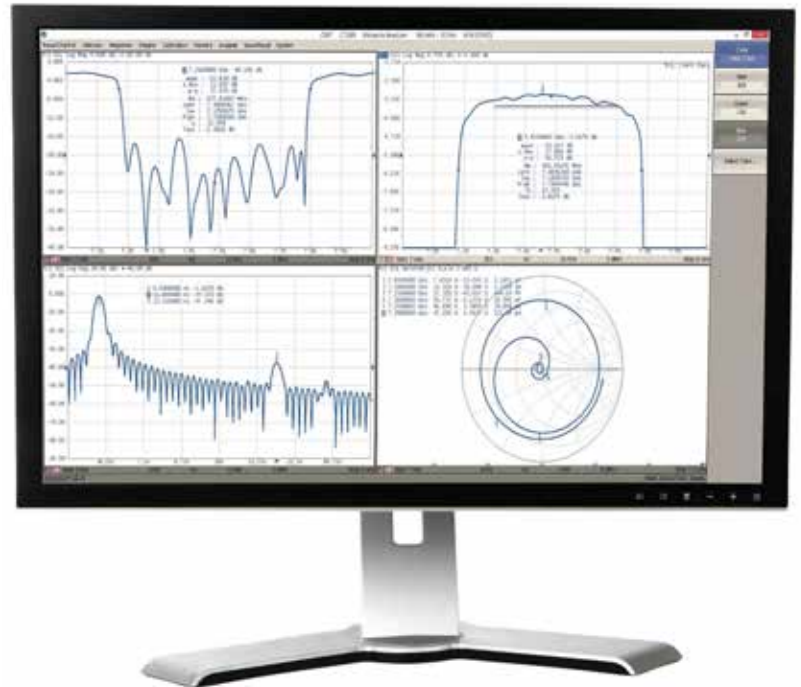

Measurement Capabilities

Measured parameters

S_{11} , S_{21} , S_{12} , S_{44} for the 2-port models and S_{11}, \dots, S_{44} for the 4-port models, and absolute power of reference and received signals at the port.

Number of measurement channels

Up to 16 independent logical channels: each logical channel is represented on the screen as an individual channel window. A logical channel is defined by such stimulus signal settings as frequency range, number of test points, or power level.

Data traces

Up to 16 data traces can be displayed in each channel window. A data trace represents one of the DUT parameters, including S-parameters, response in time domain, or input power response.

Memory traces

Each of the 16 data traces can be saved into memory for further comparison with the current values.

Data display formats

Logarithmic magnitude, linear magnitude, phase, expanded phase, group delay, SWR, real part, imaginary part, Smith chart diagram and polar diagram display formats are available.

Dynamic Range & Speed

Cobalt's combination of a wide dynamic range and high measurement speed make it an ideal VNA for measuring and tuning high performance filters.

BTS Filter Tuning

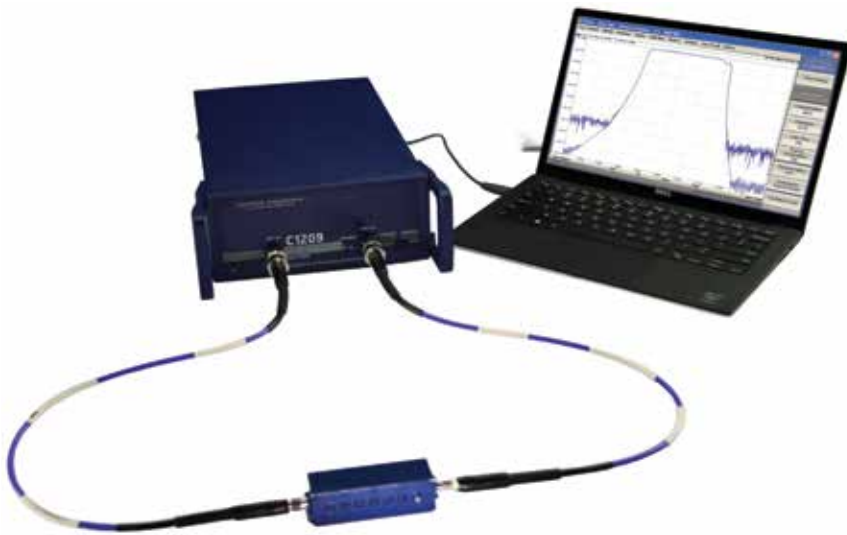

Cobalt VNAs have more than 162 dB dynamic range at 1 Hz IFBW, which allows them to maintain a wide measurement range at high measurement speeds. Measurement of all S-parameters of a BTS filter with full two-port and 801 measurement points with 1 MHz IFBW takes only 17.5ms while maintaining a measurement range of over 100 dB. This time is almost completely determined by the IFBW of the VNA. This measurement speed allows for real time tuning of high isolation BTS filters.

SAW Filters

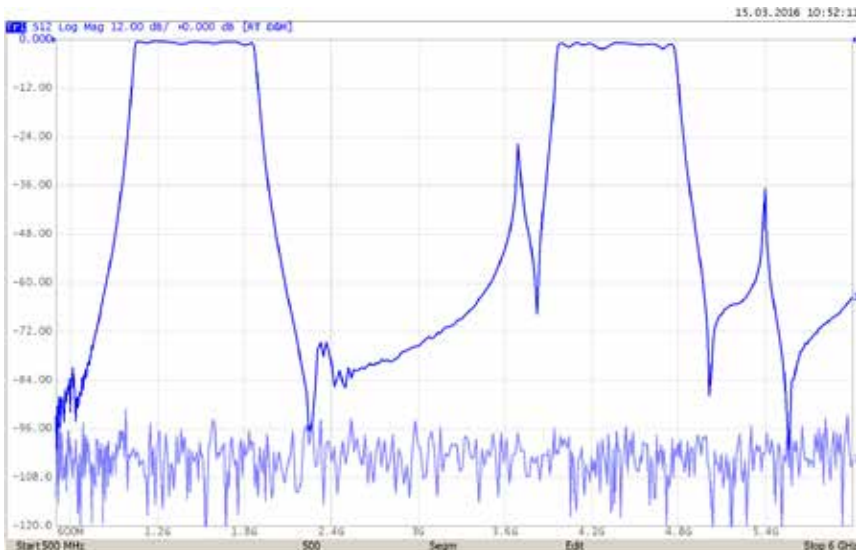

The 162 dB dynamic range of Cobalt VNAs combined with high measurement speed per point allows measurement of SAW filters' S-parameters with full 2-port calibration and 1601 measurement points in less than 32 ms while still maintaining more than 100 dB measurement range (IFBW at 1 MHz). This measurement speed corresponds to the performance of the most advanced handlers used for automatic verification of mass-produced SAW filters.

Software Application

Sweep Features

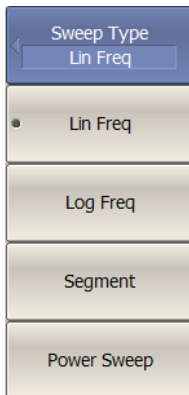

Sweep type: Linear frequency sweep and logarithmic frequency sweep are performed with fixed output power. Linear power sweep is a fixed frequency.

Measured points per sweep: Set by the user from 2 to at least 500,001.

Segment sweep features: A frequency sweep within several independent user-defined segments. Frequency range, number of sweep points, source power, and IF bandwidth can be set for each segment.

Output Power: Source power from -60 dBm to +15 dBm with a resolution of 0.05 dB. In frequency sweep mode power slope can be set up to 2 dB/GHz to compensate for high frequency attenuation in fixture cables.

Sweep Trigger:
Trigger modes: continuous, single, or hold.
Trigger sources: internal, manual, external, bus.

Trace Functions



Trace display
Data trace, memory trace, or simultaneous indication of data and memory traces.

Trace math
Data trace modification by math operations: addition, subtraction, multiplication or division of measured complex values and memory data.



Autoscaling
Automatic selection of scale division and reference level value to have the trace most effectively displayed.

Electrical delay
Calibration plane moving to compensate for the delay in the test setup, or for compensation of electrical delay in the device under test (DUT) during measurements phase deviation.

Phase offset
Defined in degrees.

Frequency Scan Segmentation

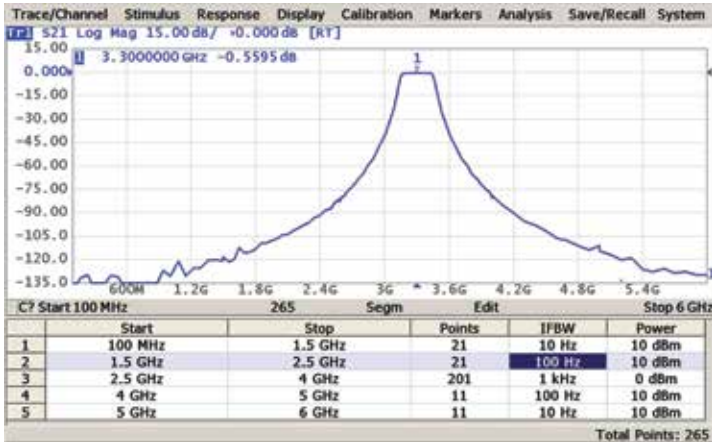

The VNA has a large frequency range with the option of frequency scan segmentation. This allows for optimal use of the instrument to realize maximum dynamic range while maintaining high measurement speed.



Power Scaling & Compression Point Recognition



The power sweep feature turns compression point recognition, one of the most fundamental and complex amplifier measurements, into a simple and accurate operation.

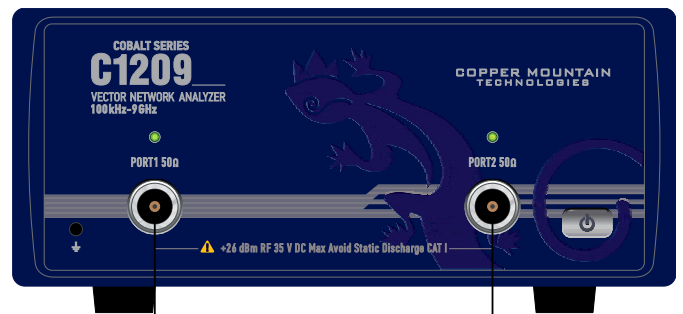

Software Application

Mixer/Converter Measurements

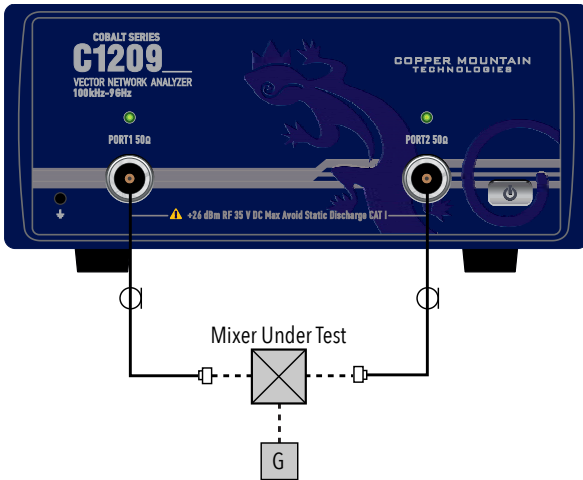

Scalar mixer/converter measurements

The scalar method allows the user to measure only the magnitude of the transmission coefficient of the mixer or other frequency translating device. No external mixers or other devices are required. The scalar method employs port frequency offset when there is a difference between the source port frequency and the receiver port frequency.

Scalar mixer/converter calibration

This is the most accurate method of calibration applied for measurements of mixers in frequency offset mode. The OPEN, SHORT, and LOAD calibration standards are used. An external power meter should be connected to the USB port directly or via USB/GPIB adapter.

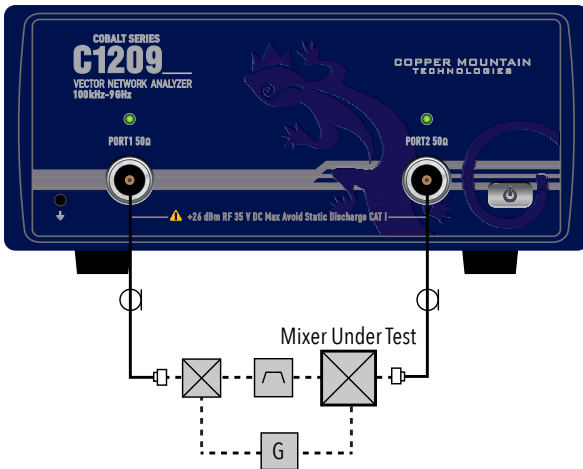

Vector mixer/converter measurements

The vector method allows measurement of both the magnitude and phase of the mixer transmission coefficient. This method requires an external mixer and an LO common to both the external mixer and the mixer under test.

Vector mixer/converter calibration

This method of calibration is applied for vector mixer measurements. OPEN, SHORT, and LOAD calibration standards are used.

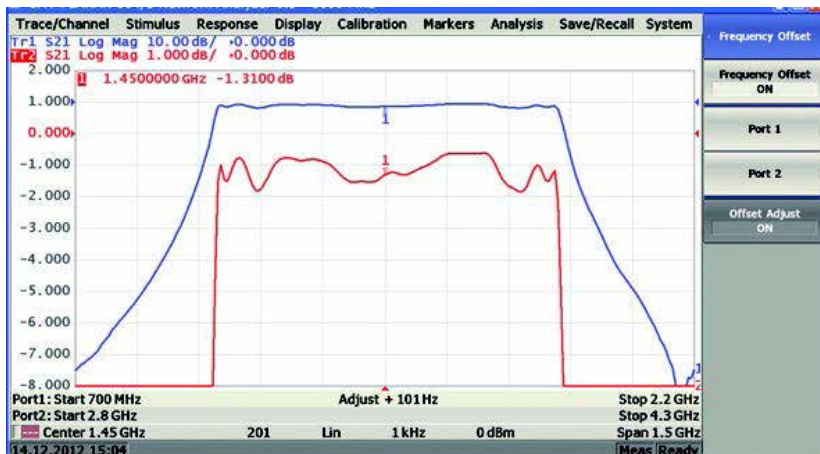

Automatic frequency offset adjustment

This function performs automatic frequency offset adjustment when the scalar mixer/converter measurements are performed to compensate for LO setting inaccuracy of the DUT.

Time Domain Measurements

This function performs conversion from frequency domain into response of the DUT to various stimulus types in time domain. Modeled stimulus types are bandpass, lowpass impulse, and lowpass step. The time domain span is arbitrarily between zero to maximum, which is determined by the frequency step. Windows of various shapes are used for tradeoff between resolution and levels of spurious sidelobes.

Here, built in time domain analysis allows the user to detect a physical impairment in a cable.

Time domain analysis allows measurements of SAW filters such as the time delay and feedthrough signal suppression.

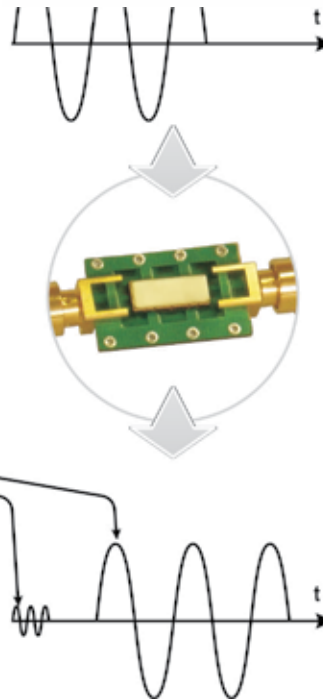
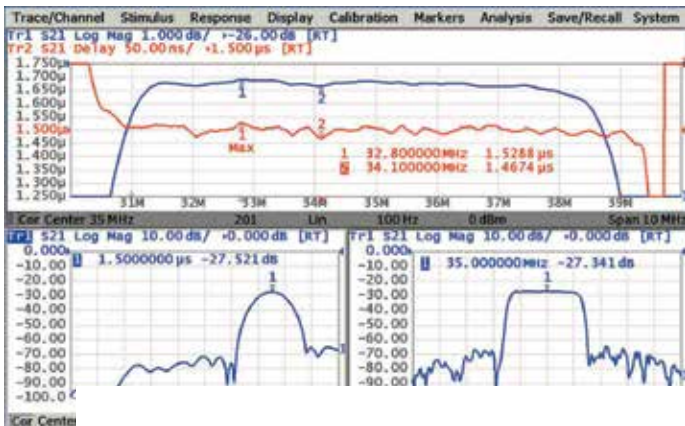
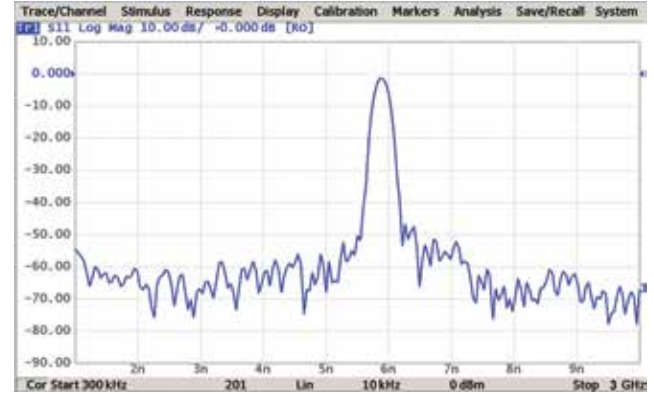

Software Application

Time Domain Gating

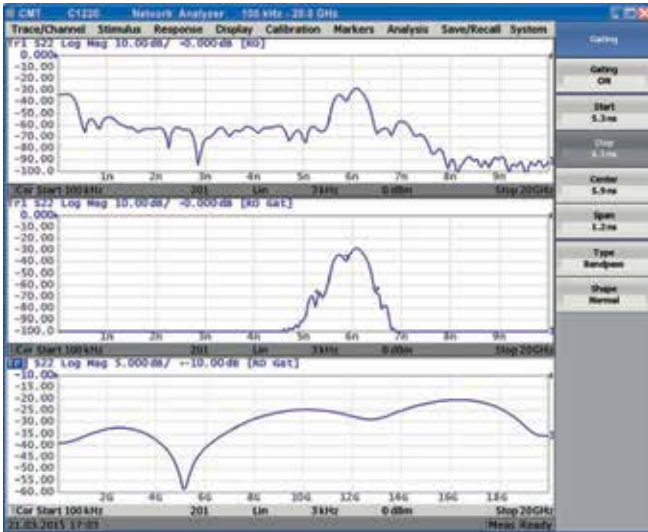

This function mathematically removes unwanted responses in the time domain, which allows the user to obtain a frequency response without effects of fixture elements.

This function applies reverse transformation back to the frequency domain after cutting out the user-defined span in the time domain. Gating filter types are bandpass or notch. For a better tradeoff between gate resolution and level of spurious sidelobes the following filter shapes are available: maximum, wide, normal and minimum.

Applications of these features include, but are not limited to: measurements of SAW filter parameters, such as filter time delay or forward transmission attenuation.

Limit Testing

Limit testing is a function for automatic pass/fail based on measurement results. Pass/fail is based on comparison of the trace to the limit line set by the user and can consist of one or several segments.

Each segment checks the measurement value for failing either the upper or lower limit, or both. The limit line segment is defined by specifying the coordinates of the beginning (X0, Y0) and the end (X1, Y1) of the segment, and type of the limit. The MAX or MIN limit types check if the trace falls outside of the upper or lower limit, respectively.

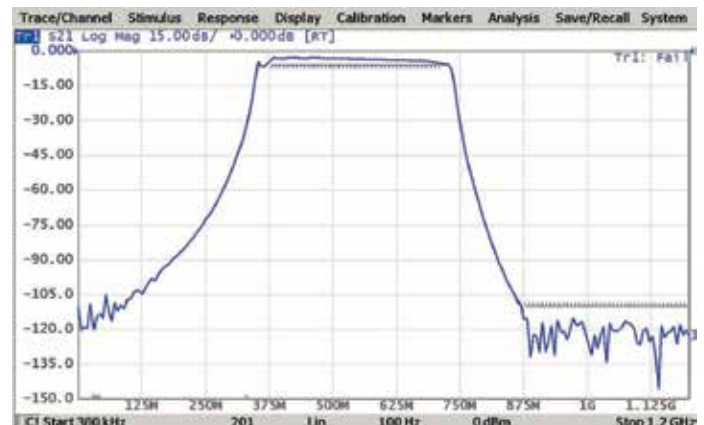
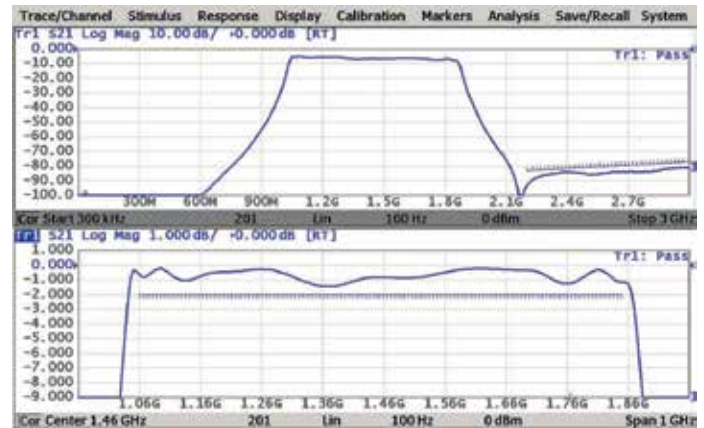

Embedding

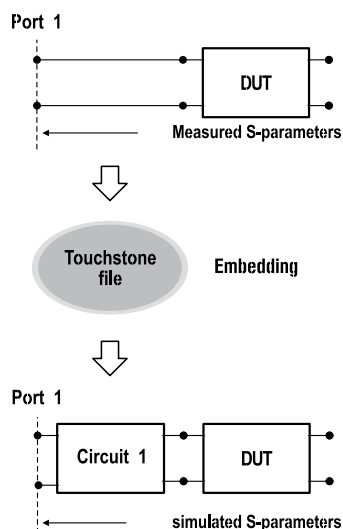

Allows the user to mathematically simulate the DUT parameters after virtual connection through a fixture circuit between the calibration plane and the DUT. This circuit is described by an S-parameter matrix in a Touchstone file.

De-Embedding

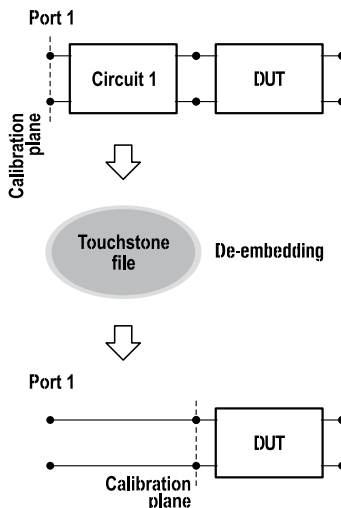

Allows users to mathematically exclude from the measurement result the effect of the fixture circuit connected between the calibration plane and a DUT. This circuit should be described by an S-parameter matrix in a Touchstone file.

AUX Ports (Optional)



Some measurement applications, for example characterization of a log amplifier, involve measurement of the detector's output voltage or an amplifier DUT's efficiency over frequency or input power, which necessitates making voltage measurements in addition to standard S-parameter measurements. Cobalt series analyzers configured with option HW-C-AUX incorporate two general-purpose analog voltage input ports to measure system or DUT voltages synchronously with the VNA sweep. Either input may be configured for +/- 1.0 VDC or +/- 10.0 VDC operation and voltage measurements viewed directly in the VNA's Windows application.

Software Application

Port Impedance Conversion



This function converts the S-parameters measured at a 50 Ω port into values which would be seen if measured at a test port with arbitrary impedance.

S-Parameter Conversion

This function allows for conversion of measured S-parameters to the following parameters: reflection impedance and admittance, transmission impedance and admittance, and inverse S-parameters.

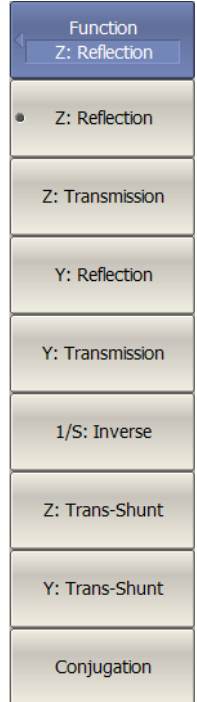

Data Output

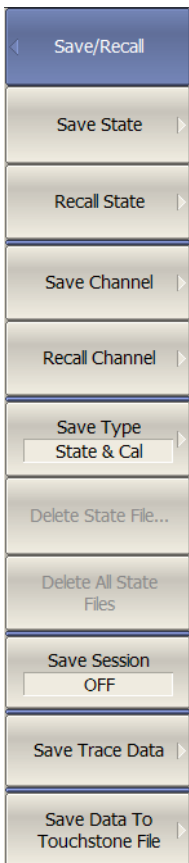

Analyzer State

All state, calibration and measurement data can be saved to an Analyzer state file on the hard disk and later recalled into the software program. The following four types of states are available: State, State & Cal, Stat & Trace, or All.

Channel State

A channel state can be saved into the Analyzer state. The procedure is similar to saving of the Analyzer state, and the same types are applied to channel saving. Unlike Analyzer state, channel state is saved into the Analyzer volatile memory (not to the hard disk) and is cleared when power to the Analyzer is switched off. For channel state, there are four memory registers A, B, C, D. Channel state saving allows the user to easily copy the settings of one channel to another one.

Trace Data CSV File

The Analyzer allows the user to save an individual trace's data as a CSV file (comma separated values). The active trace stimulus and response values, in its current format are saved to a *.CSV file.

Trace Data Touchstone File

Allows the user to save S-parameters to a Touchstone file. The Touchstone file contains frequency values and S-parameters. Files of this format are industry-standard for most circuit simulator programs. The .s2p, .s3p, and .s4p files are used for saving all S-parameters of a device. The .s1p files are used for saving S_{11} or S_{22} parameters of a 1-port device. The Touchstone file saving function is applied to individual channels.

Screenshot capture

A print function is provided with a preview feature, which allows for viewing the image to be printed on the screen, and/or save it to a file. Screenshots can be printed using three different applications: MS Word, Image Viewer for Windows, or the Print Wizard of the Analyzer. Each screenshot can be printed in color, grayscale, black and white, or inverted for visibility or to save ink. The current date and time can be added to each capture before it is transferred to the printing application, resulting in quick and easy test reporting.

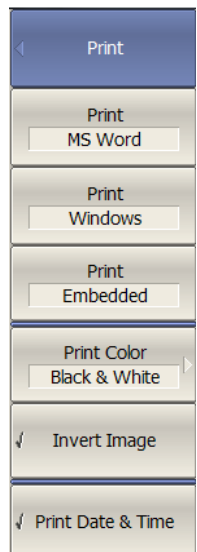

Calibration

User Calibration

Calibration

Calibration of a test setup (which includes the VNA, cables, and adapters) significantly increases the accuracy of measurements. Calibration allows for correction of errors caused by imperfections in the measurement system: system directivity, source and load match, tracking, and isolation.

Calibration methods

The following calibration methods of various sophistication and accuracy are available:

- Reflection & transmission normalization
- Full one-port calibration
- One-path two-port calibration
- Full two-port, three-port and four-port calibration

Reflection and transmission normalization

This is the simplest calibration method; however, it provides reduced accuracy compared to other methods.

Full one-port calibration

Method of calibration performed for one-port reflection measurements. It ensures high accuracy.

One-path two-port calibration

Method of calibration performed for reflection and one-way transmission measurements, for example for measuring S_{11} and S_{21} only. It ensures high accuracy for reflection measurements, and moderate accuracy for transmission measurements.

Full two-port, three-port, four-port calibration

This method of calibration is performed for full S-parameter matrix measurement of a two-port DUT, ensuring high accuracy.

TRL calibration

Method of calibration performed for full S-parameter matrix measurement of a two-port, three-port, or four-port DUT. It ensures higher accuracy than two-port calibration. LRL and LRM modifications of this calibration method are available.

Mechanical Calibration Kits

The user can select one of the predefined calibration kits of various manufacturers or define a new calibration kit.

Electronic Calibration Modules

Electronic, or automatic, calibration modules offered by CMT make calibration faster and easier than traditional mechanical calibration.

Sliding load calibration standard

The use of a sliding load calibration standard allows for a significant increase in calibration accuracy at high frequencies compared to the fixed load calibration standard.

"Unknown" thru calibration standard

The use of a generic two-port reciprocal circuit instead of a characterized Thru in full two-port calibration allows the user to calibrate the VNA for measurement of "non-insertable" devices.

Defining of calibration standards

Different methods of calibration standard definition are available: standard definition by polynomial model and standard definition by data (S-parameters).

Error correction interpolation

When the user changes any settings such as the start/stop frequencies or the number of sweep points, compared to the settings at the moment of calibration, interpolation or extrapolation of the calibration coefficients will be applied.

Power calibration

Power calibration allows more stable power level setting at the DUT input. An external power meter should be connected to the USB port directly or via a USB/GPIB adapter.

Receiver calibration

This method calibrates the receiver gain at the absolute signal power measurement.

Automation

Automation Languages

We maintain code examples and guides in the following languages:

- MATLAB
- C++
- LabVIEW
- Visual Basic (Excel)
- Python
- And many more

Measurement Automation

COM/DCOM interface

The VNA software provides a COM/DCOM (ActiveX) interface, allowing the instrument to be used as a part of a larger test system and in other specialized applications. The VNA program runs as a COM/DCOM server, while the user program runs as a client.

SCPI via TCP Socket

Alternatively a TCP socket is provided for automation from either localhost--the same machine running the VNA software application--or from a second PC connected by an IP network. The SCPI command is largely compatible with legacy instruments, maximizing code reuse for existing test automation platforms.

SCPI via HiSlip

Based on VXI-11, the HiSlip interface uses the same SCPI command set but further allows for instrument discovery and provides ease of automation through Visa library of your choice.

LabView compatible

The device and its software are fully compatible with LabView applications, for ultimate flexibility in user-generated programming and automation.

Our command set is modeled after industry-standard legacy equipment; porting code is straightforward and we can help. Complete installation of any CMT software comes with multiple programming examples and guides installed in the C:\VNA\S2VNA\ or C:\VNA\S4VNA\ Programming Examples and Guides directory.

CMT software includes many features that other vendors offer as options, including Time Domain capability, S-parameter Embedding and De-Embedding, Frequency Offset, and Vector Mixer Calibration functionality. No integrated PC means faster data processing turnaround and regular updates that are easy to install. Less complexity in the VNA leads to fewer points of failure that cost you production/development time.

Software comes with all the features developers have come to expect: segmented frequency sweeps, linear/logarithmic sweeps, power sweeps, multiple trace formats, 16 channels max. with up to 16 traces each, marker math, and limit tests. These provide added value to production testing by simplifying measurement interpretation. Plugins can add wide ranges of functionality and can be developed upon request. Examples include streamlined production applications, functionality to trigger with external generators, and virtual circuit matching modeling.

Automation Features

- Segmented frequency sweeps
- Power sweeps
- 16 channels max. with up to 16 traces each
- Limit tests
- Linear/logarithmic sweeps
- Multiple trace formats
- Marker math





COBALT Fx

 **Farran
Technology**

Farran Technology and Copper Mountain Technologies, globally recognized innovators, with a combined 50 years' experience in RF test and measurement systems have partnered to create CobaltFx; your new millimeter-wave frequency extension solution.

CobaltFx is the first mmWave frequency extension solution that utilizes a 9 GHz VNA. CobaltFx's high dynamic range and directivity allow for highly accurate and stable millimeter-wave S-parameter measurements in three dedicated waveguide bands: 50-75 GHz, 60-90 GHz, and 75-110 GHz. CobaltFx offers an unparalleled combination of price, performance, flexibility and size.

C4209, the VNA used in this system, is from Copper Mountain Technologies' industry leading Cobalt Series. It features fast sweep speeds down to 10 microseconds per point and a dynamic range of up to 162 dB, all comprised in a compact, USB form factor. C4209 works seamlessly with Farran Technology's millimeter-wave FEV frequency extenders.

The extenders are packaged in small and versatile enclosures that allow for flexible port arrangements with respect to the waveguide. Waveguide ports are manufactured in accordance to the new IEEE 1785-2a standard and ensure industry leading alignment and repeatability of connection, allowing for long interval times between calibration. The system comes with a precision calibration kit containing flush short, offset piece and broadband load and allows for full 12-term port calibration.

Visit www.coppermountaintech.com or www.farran.com for more information.

C1209 Specifications¹

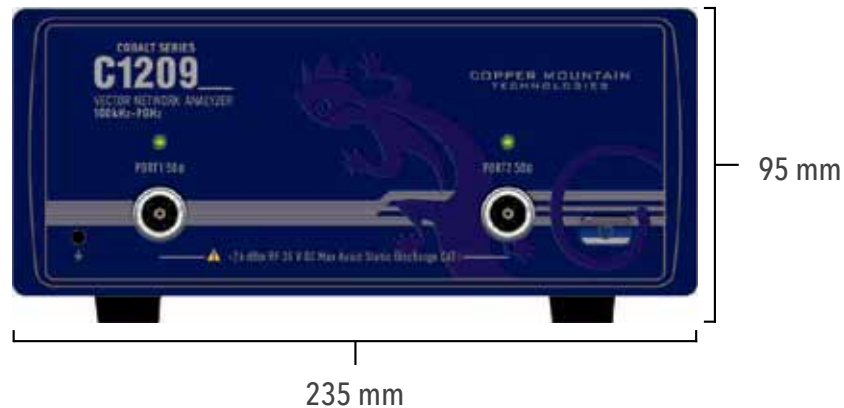

Primary Specifications

Impedance	50 Ohm	
Test port connector	N-type Female	
Number of test ports	2	
Frequency range	100 kHz to 9.0 GHz	
Full CW Frequency	$\pm 2 \times 10^{-6}$	
Frequency setting resolution	1 Hz	
Number of measurement points	2 to 500,001	
Measurement bandwidths with 1/1.5/2/3/5/7 steps	1 Hz to 2 MHz	
Dynamic range		
	100 kHz to 1 MHz; 1 Hz IF BW	115 dB
	1 MHz to 8 GHz; 1 Hz IF BW	158 dB/162 dB, typ.
	8 GHz to 9 GHz; 1 Hz IF BW	148 dB/152 dB, typ.
Time per point (Typ.)	10 μ sec	
Port switchover time (Typ.)	0.2 msec	

Measurement Accuracy

Transmission ²	(Magnitude/Phase)
100 kHz to 1 MHz	
5 dB to 15 dB	0.2 dB/2°
-30 dB to 5 dB	0.1 dB/1°
-50 dB to -30 dB	0.2 dB/2°
-70 dB to -50 dB	1.0 dB/6°
1 MHz to 8 GHz	
5 dB to 15 dB	0.2 dB/2°
-70 dB to 5 dB	0.1 dB/1°
-90 dB to -70 dB	0.2 dB/2°
-110 dB to -90 dB	1.0 dB/6°
8 GHz to 9 GHz	
5 dB to 15 dB	0.2 dB/2°
-60 dB to 5 dB	0.1 dB/1°
-80 dB to -60 dB	0.2 dB/2°
-100 dB to -80 dB	1.0 dB/6°
Reflection	(Magnitude/Phase)
-15 dB to 0 dB	0.4 dB/3°
-25 dB to -15 dB	1.0 dB/6°
-35 dB to -25 dB	3.0 dB/20°
Trace noise magnitude (3 kHz IF BW)	
100 kHz to 1 MHz	0.005 dB RMS
1 MHz to 9 GHz	0.001 dB RMS
Temperature dependence	0.020 dB/°C, 0.010 dB/°C typ.

Effective System Data

Effective directivity	46 dB
Effective source match	40 dB
Effective load match	46 dB

Test Port

Directivity (without system error correction)	
100 kHz to 1 MHz	12 dB
1 MHz to 9 GHz	18 dB

[1] All specifications subject to change without notice.

[2] At 23 °C +/- 5 °C after warmup time, with +/- 1°C ambient deviation from calibration temperature, at high output power

© Copper Mountain Technologies - www.coppermountaintech.com - Rev. 2017Q2

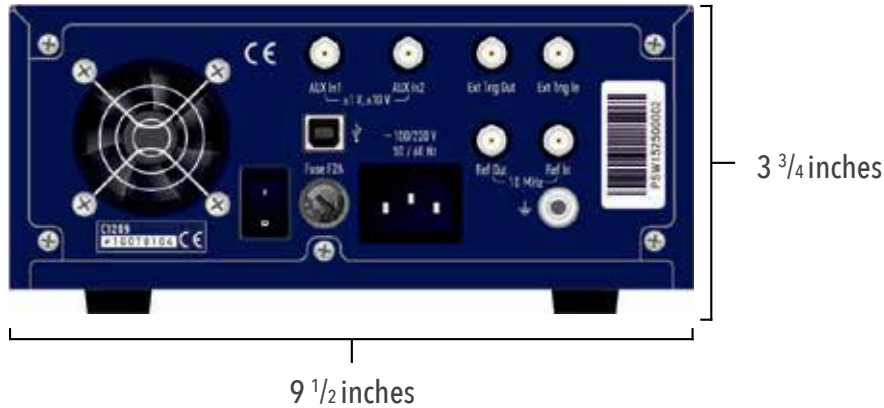

Test Port Output

Match (without system error correction)	
100 kHz to 1 MHz	12 dB
1 MHz to 9 GHz	20 dB
Power Range	-60 dBm to +15 dBm
Power Accuracy	±1.5 dB
Power Resolution	0.050 dB
Harmonic distortion (Power out 0 dBm)	-25 dBc
Non-harmonic spurious (Power out 0 dBm)	-30 dBc

Test Port Input

Match (without system error correction)	
100 kHz to 1 MHz	12 dB
1 MHz to 9 GHz	20 dB
Damage Level	+26 dBm
Damage DC Voltage	35 V
Noise Floor	
100 kHz to 1 MHz	-100 dBm/Hz
1 MHz to 8 GHz	-143 dBm/Hz
8 GHz to 9 GHz	-133 dBm/Hz

Measurement Speed

Number of points (IF bandwidth 1 MHz)	Uncorrected	2-Port Calibration
51	1.0 ms	2.0 ms
201	2.6 ms	5.0 ms
401	4.6 ms	9.0 ms
1601	16.7 ms	33.3 ms

External Reference Input

Connector type	BNC Female
External reference frequency	10 MHz
Input level	-2 dBm to 4 dBm
Input impedance at <<Ref IN 10 MHz>>	50 Ohm

External Reference Output

<<OUT 10 MHz>> connector type	BNC Female
Output reference signal level at 50 Ohm impedance	0 dBm to 2 dBm

External Trigger Input

Type	BNC, Female
Input level low threshold voltage	0.8 V
Input level high threshold voltage	2.7 V
Input level range	0 to 5 V
Pulse width	2 µsec
Polarity	Positive or Negative

External Trigger Output

Type	BNC, Female
Maximum output current	20 mA
Output level low threshold voltage	0.4 V
Output level high threshold voltage	3.0 V
Polarity	Positive or Negative

System & Power

Operating temperature	5°C to 40°C (41°F to 104°F)
Storage temperature	-45°C to 55°C (-49°F to 131°F)
Humidity	90% at 25°C (77°F)
Atmospheric pressure	84.0 kPa to 106.7 kPa
Power Supply	110-240 V, 50-60 Hz
Power Consumption	40.0 W
Weight	5.5 kg/194 oz

Factory Adjustment

Recommended Factory Adjustment Interval	3 Years
------------------------------------------------	---------

C2209 Specifications¹

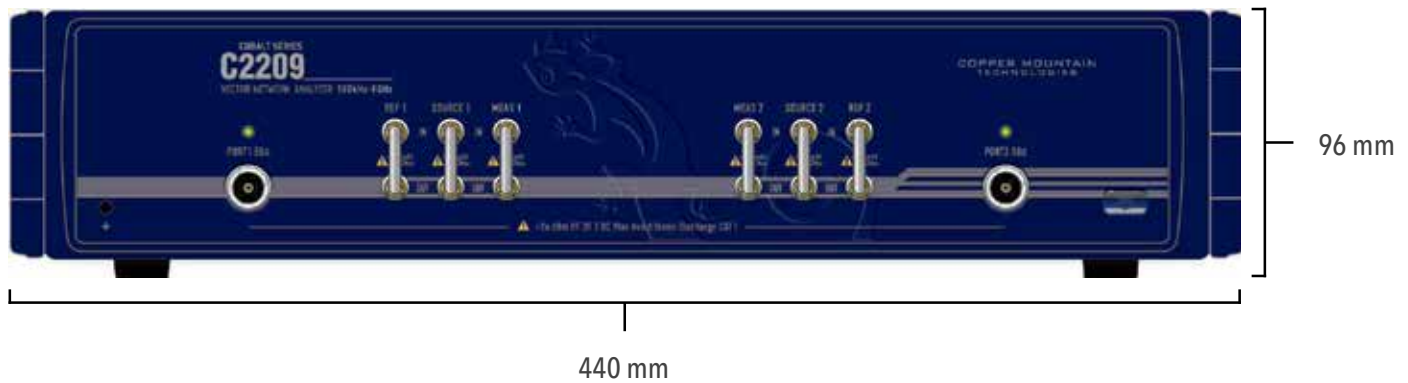

Primary Specifications

Impedance	50 Ohm
Test port connector	N-type Female
Number of test ports	2
Direct access	Yes; Source, Ref, and Meas
Frequency range	100 kHz to 9.0 GHz
Full CW Frequency	$\pm 2 \times 10^6$
Frequency setting resolution	1 Hz
Number of measurement points	2 to 500,001
Measurement bandwidths with 1/1.5/2/3/5/7 steps	1 Hz to 2 MHz
Dynamic range	
100 kHz to 1 MHz; 1 Hz IF BW	115 dB
1 MHz to 8 GHz; 1 Hz IF BW	158 dB/162 dB, typ.
8 GHz to 9 GHz; 1 Hz IF BW	148 dB/152 dB, typ.
Time per point (Typ.)	10 μ sec
Port switchover time (Typ.)	0.2 msec

Measurement Accuracy

Transmission ²	(Magnitude/Phase)
100 kHz to 1 MHz	
5 dB to 15 dB	0.2 dB/2°
-30 dB to 5 dB	0.1 dB/1°
-50 dB to -30 dB	0.2 dB/2°
-70 dB to -50 dB	1.0 dB/6°
1 MHz to 8 GHz	
5 dB to 15 dB	0.2 dB/2°
-70 dB to 5 dB	0.1 dB/1°
-90 dB to -70 dB	0.2 dB/2°
-110 dB to -90 dB	1.0 dB/6°
8 GHz to 9 GHz	
5 dB to 15 dB	0.2 dB/2°
-60 dB to 5 dB	0.1 dB/1°
-80 dB to -60 dB	0.2 dB/2°
-100 dB to -80 dB	1.0 dB/6°
Reflection	(Magnitude/Phase)
-15 dB to 0 dB	0.4 dB/3°
-25 dB to -15 dB	1.0 dB/6°
-35 dB to -25 dB	3.0 dB/20°
Trace noise magnitude (3 kHz IF BW)	
100 kHz to 1 MHz	0.005 dB RMS
1 MHz to 9 GHz	0.001 dB RMS
Temperature dependence	0.020 dB/°C, 0.010 dB/°C typ.

Schematic Diagram of Cobalt C2209

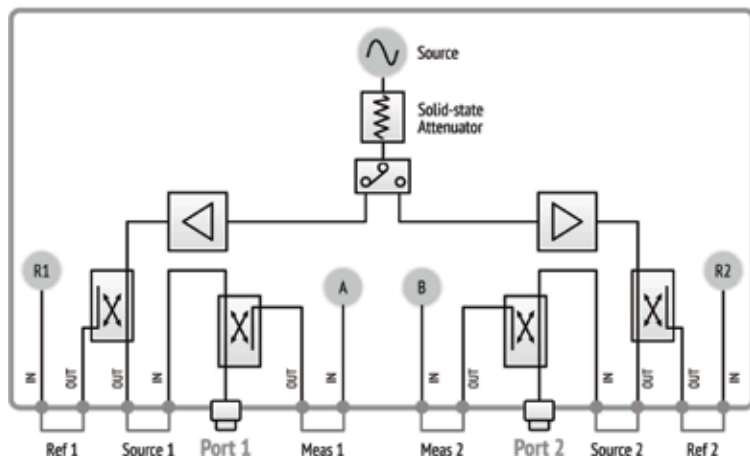

Effective System Data

Effective directivity	46 dB
Effective source match	40 dB
Effective load match	46 dB

Test Port

Directivity (without system error correction)	
100 kHz to 1 MHz	12 dB
1 MHz to 9 GHz	15 dB

[1] All specifications subject to change without notice.

[2] At 23 °C +/- 5 °C after warmup time, with +/- 1°C ambient deviation from calibration temperature, at high output power

© Copper Mountain Technologies - www.coppermountaintech.com - Rev. 2017Q2

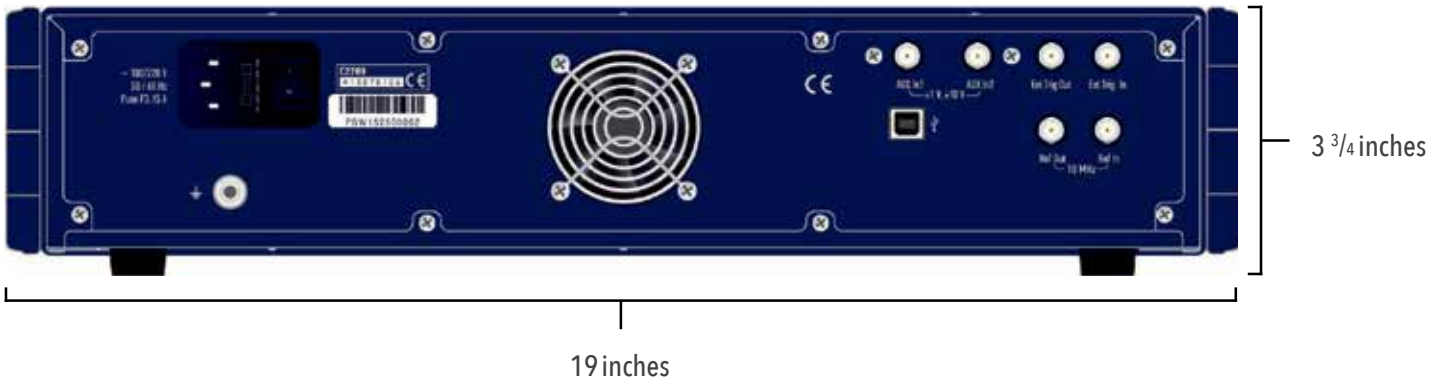

Test Port Output

Match (without system error correction)	
100 kHz to 1 MHz	12 dB
1 MHz to 9 GHz	15 dB
Power Range	-60 dBm to +15 dBm
Power Accuracy	±1.5 dB
Power Resolution	0.050 dB
Harmonic distortion (Power out 0 dBm)	-25 dBc
Non-harmonic spurious (Power out 0 dBm)	-30 dBc

Test Port Input

Match (without system error correction)	
100 kHz to 1 MHz	12 dB
1 MHz to 9 GHz	15 dB
Damage Level	+26 dBm
Damage DC Voltage	35 V
Noise Floor	
100 kHz to 1 MHz	-100 dBm/Hz
1 MHz to 8 GHz	-143 dBm/Hz
8 GHz to 9 GHz	-133 dBm/Hz

Measurement Speed

Number of points (IF bandwidth 1 MHz)	Uncorrected	2-Port Calibration
51	1.0 ms	2.0 ms
201	2.6 ms	5.0 ms
401	4.6 ms	9.0 ms
1601	16.7 ms	33.3 ms

External Reference Input

Connector type	BNC Female
External reference frequency	10 MHz
Input level	-2 dBm to 4 dBm
Input impedance at <<Ref IN 10 MHz>>	50 Ohm

External Reference Output

<<OUT 10 MHz>> connector type	BNC Female
Output reference signal level at 50 Ohm impedance	0 dBm to 2 dBm

External Trigger Input

Type	BNC, Female
Input level low threshold voltage	0.8 V
Input level high threshold voltage	2.7 V
Input level range	0 to 5 V
Pulse width	2 µsec
Polarity	Positive or Negative

External Trigger Output

Type	BNC, Female
Maximum output current	20 mA
Output level low threshold voltage	0.4 V
Output level high threshold voltage	3.0 V
Polarity	Positive or Negative

System & Power

Operating temperature	5°C to 40°C (41°F to 104°F)
Storage temperature	-50°C to 70°C (-58°F to 158°F)
Humidity	90% at 25°C (77°F)
Atmospheric pressure	84.0 kPa to 106.7 kPa
Power Supply	110-240 V, 50-60 Hz
Power Consumption	40.0 W
Weight	7.0 kg/247 oz

Factory Adjustment

Recommended Factory Adjustment Interval	3 Years
-----------------------------------------	---------

Direct Receiver Access Ports

Maximum input, Ref 1&2	-3 dBm
Maximum input, Source 1&2	15 dBm
Maximum input, Meas 1&2	-3 dBm
Damage level, Ref 1&2	13 dBm
Damage level, Source 1&2	26 dBm
Damage level, Meas 1&2	13 dBm
Damage DC voltage, Ref 1&2	0 V DC
Damage DC voltage, Source 1&2	35 V DC
Damage DC voltage, Meas 1&2	0 V DC

C4209 Specifications¹

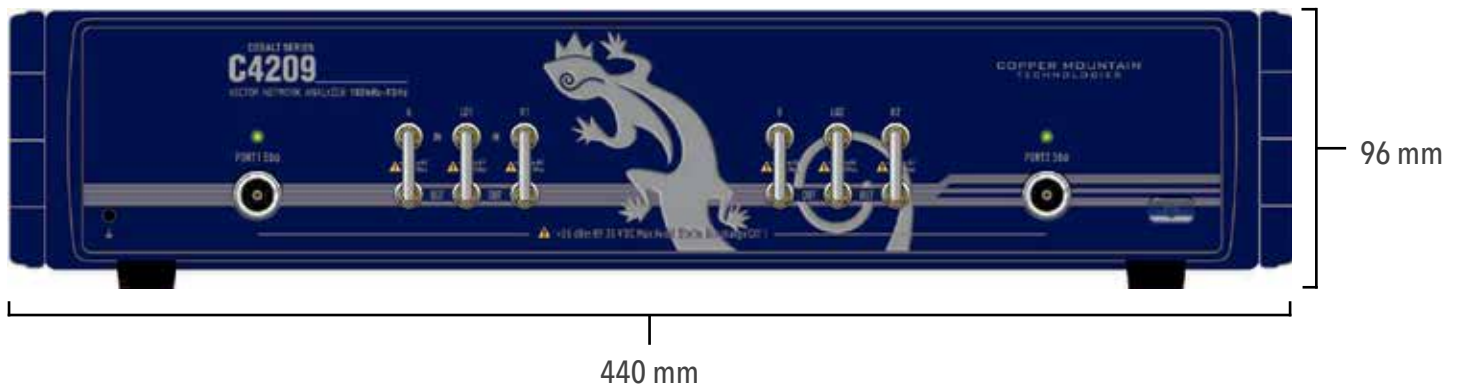

Primary Specifications

Impedance	50 Ohm
Test port connector	N-type Female
Number of test ports	2
Frequency extender compatible	Yes; CobaltFx (2 ports)
Frequency range	100 kHz to 9.0 GHz
Full CW Frequency	$\pm 2 \times 10^{-6}$
Frequency setting resolution	1 Hz
Number of measurement points	2 to 500,001
Measurement bandwidths with 1/1.5/2/3/5/7 steps	1 Hz to 2 MHz
Dynamic range	
100 kHz to 1 MHz; 1 Hz IF BW	115 dB
1 MHz to 8 GHz; 1 Hz IF BW	158 dB/162 dB, typ.
8 GHz to 9 GHz; 1 Hz IF BW	148 dB/152 dB, typ.
Time per point (Typ.)	10 μ sec
Port switchover time (Typ.)	0.2 msec

Measurement Accuracy

Transmission ²	(Magnitude/Phase)
100 kHz to 1 MHz	
5 dB to 15 dB	0.2 dB/2°
-30 dB to 5 dB	0.1 dB/1°
-50 dB to -30 dB	0.2 dB/2°
-70 dB to -50 dB	1.0 dB/6°
1 MHz to 8 GHz	
5 dB to 15 dB	0.2 dB/2°
-70 dB to 5 dB	0.1 dB/1°
-90 dB to -70 dB	0.2 dB/2°
-110 dB to -90 dB	1.0 dB/6°
8 GHz to 9 GHz	
5 dB to 15 dB	0.2 dB/2°
-60 dB to 5 dB	0.1 dB/1°
-80 dB to -60 dB	0.2 dB/2°
-100 dB to -80 dB	1.0 dB/6°
Reflection (Magnitude/Phase)	
-15 dB to 0 dB	0.4 dB/3°
-25 dB to -15 dB	1.0 dB/6°
-35 dB to -25 dB	3.0 dB/20°
Trace noise magnitude (3 kHz IF BW)	
100 kHz to 1 MHz	0.005 dB RMS
1 MHz to 9 GHz	0.001 dB RMS
Temperature dependence	0.020 dB/°C, 0.010 dB/°C typ.

Effective System Data

Effective directivity	46 dB
Effective source match	40 dB
Effective load match	46 dB

Test Port

Directivity (without system error correction)	
100 kHz to 1 MHz	12 dB
1 MHz to 9 GHz	18 dB

[1] All specifications subject to change without notice.

[2] At 23 °C +/- 5 °C after warmup time, with +/- 1°C ambient deviation from calibration temperature, at high output power

© Copper Mountain Technologies - www.coppermountaintech.com - Rev. 2017Q2

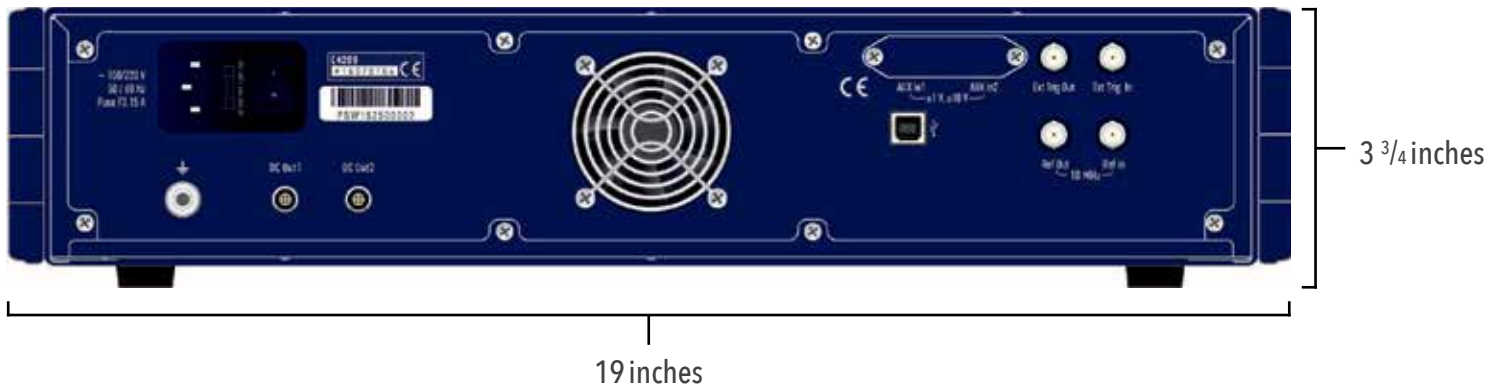

Test Port Output

Match (without system error correction)	
100 kHz to 1 MHz	12 dB
1 MHz to 9 GHz	20 dB
Power Range	-60 dBm to +15 dBm
Power Accuracy	±1.5 dB
Power Resolution	0.050 dB
Harmonic distortion (Power out 0 dBm)	-25 dBc
Non-harmonic spurious (Power out 0 dBm)	-30 dBc

Test Port Input

Match (without system error correction)	
100 kHz to 1 MHz	12 dB
1 MHz to 9 GHz	20 dB
Damage Level	+26 dBm
Damage DC Voltage	35 V
Noise Floor	
100 kHz to 1 MHz	-100 dBm/Hz
1 MHz to 8 GHz	-143 dBm/Hz
8 GHz to 9 GHz	-133 dBm/Hz

Measurement Speed

Number of points (IF bandwidth 1 MHz)	Uncorrected	2-Port Calibration
51	1.0 ms	2.0 ms
201	2.6 ms	5.0 ms
401	4.6 ms	9.0 ms
1601	16.7 ms	33.3 ms

External Reference Input

Connector type	BNC Female
External reference frequency	10 MHz
Input level	-2 dBm to 4 dBm
Input impedance at <<Ref IN 10 MHz>>	50 Ohm

External Reference Output

<<OUT 10 MHz>> connector type	BNC Female
Output reference signal level at 50 Ohm impedance	0 dBm to 2 dBm

External Trigger Input

Type	BNC, Female
Input level low threshold voltage	0.8 V
Input level high threshold voltage	2.7 V
Input level range	0 to 5 V
Pulse width	2 µsec
Polarity	Positive or Negative

External Trigger Output

Type	BNC, Female
Maximum output current	20 mA
Output level low threshold voltage	0.4 V
Output level high threshold voltage	3.0 V
Polarity	Positive or Negative

System & Power

Operating temperature	5°C to 40°C (41°F to 104°F)
Storage temperature	-50°C to 70°C (-58°F to 158°F)
Humidity	90% at 25°C (77°F)
Atmospheric pressure	84.0 kPa to 106.7 kPa
Power Supply	110-240 V, 50-60 Hz
Power Consumption	75.0 W
Weight	7.0 kg/247 oz

Factory Adjustment

Recommended Factory Adjustment Interval	3 Years
------------------------------------------------	---------

C1409 Specifications¹

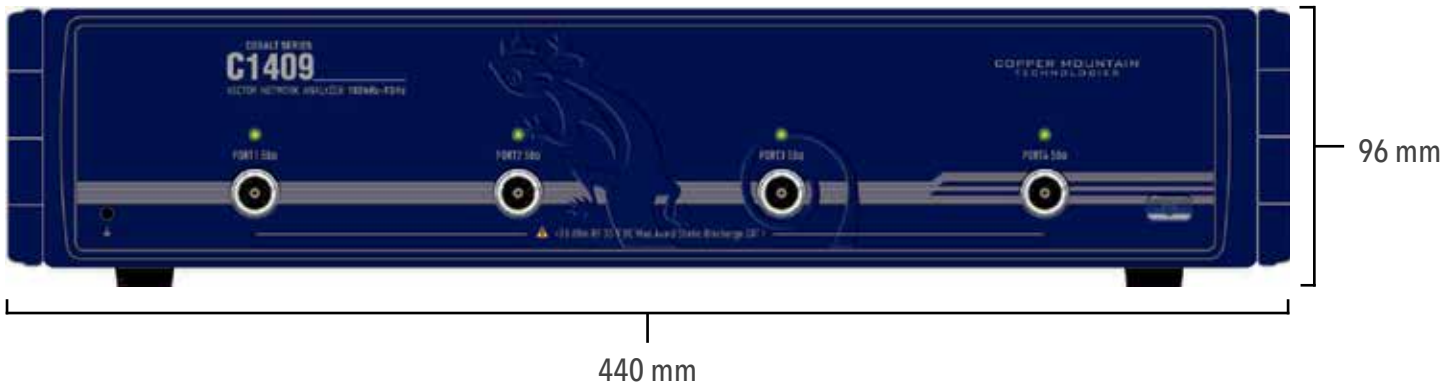

Primary Specifications

Impedance	50 Ohm
Test port connector	N-type Female
Number of test ports	4
Frequency range	100 kHz to 9.0 GHz
Full CW Frequency	$\pm 2 \times 10^6$
Frequency setting resolution	1 Hz
Number of measurement points	2 to 500,001
Measurement bandwidths with 1/1.5/2/3/5/7 steps	1 Hz to 2 MHz
Dynamic range	
100 kHz to 1 MHz; 1 Hz IF BW	115 dB
1 MHz to 8 GHz; 1 Hz IF BW	158 dB/162 dB, typ.
8 GHz to 9 GHz; 1 Hz IF BW	148 dB/152 dB, typ.
Time per point (Typ.)	10 μ sec
Port switchover time (Typ.)	0.2 msec

Effective System Data

Effective directivity	46 dB
Effective source match	40 dB
Effective load match	46 dB

Measurement Accuracy

Transmission ²	(Magnitude/Phase)
100 kHz to 1 MHz	
5 dB to 15 dB	0.2 dB/2°
-30 dB to 5 dB	0.1 dB/1°
-50 dB to -30 dB	0.2 dB/2°
-70 dB to -50 dB	1.0 dB/6°
1 MHz to 8 GHz	
5 dB to 15 dB	0.2 dB/2°
-70 dB to 5 dB	0.1 dB/1°
-90 dB to -70 dB	0.2 dB/2°
-110 dB to -90 dB	1.0 dB/6°
8 GHz to 9 GHz	
5 dB to 15 dB	0.2 dB/2°
-60 dB to 5 dB	0.1 dB/1°
-80 dB to -60 dB	0.2 dB/2°
-100 dB to -80 dB	1.0 dB/6°
Reflection	(Magnitude/Phase)
-15 dB to 0 dB	0.4 dB/3°
-25 dB to -15 dB	1.0 dB/6°
-35 dB to -25 dB	3.0 dB/20°
Trace noise magnitude (3 kHz IF BW)	
100 kHz to 1 MHz	0.005 dB RMS
1 MHz to 9 GHz	0.001 dB RMS
Temperature dependence	0.020 dB/°C, 0.010 dB/°C typ.

Schematic Diagram of Cobalt C1409

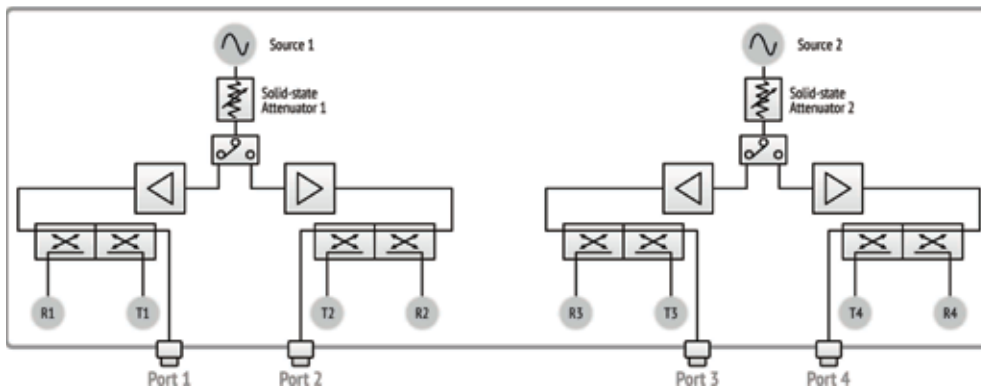

[1] All specifications subject to change without notice.

[2] At 23 °C +/- 5 °C after warmup time, with +/- 1°C ambient deviation from calibration temperature, at high output power

© Copper Mountain Technologies - www.coppermountaintech.com - Rev. 2017Q2

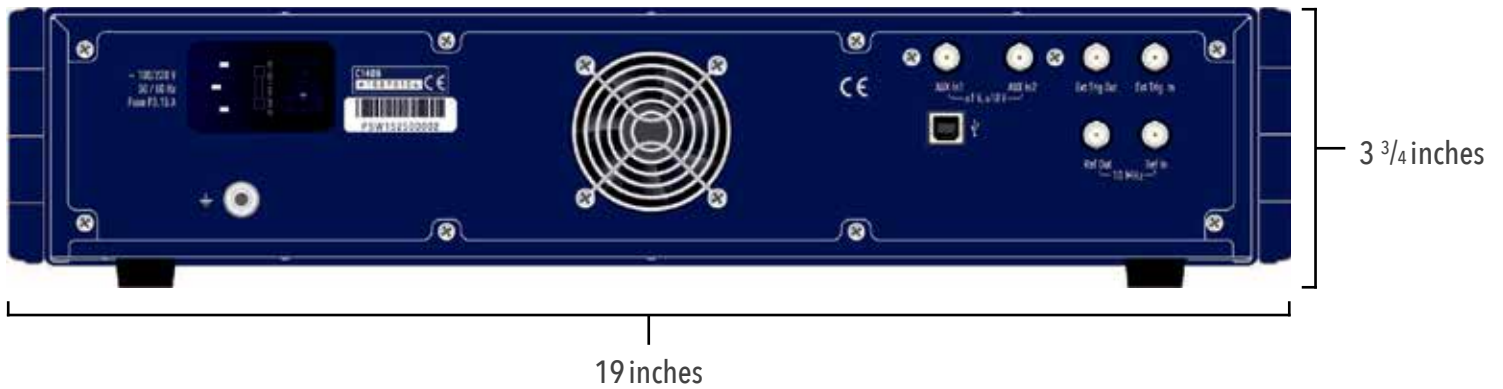

Test Port

Directivity (without system error correction)	
100 kHz to 1 MHz	12 dB
1 MHz to 9 GHz	18 dB

Test Port Output

Match (without system error correction)	
100 kHz to 1 MHz	12 dB
1 MHz to 9 GHz	20 dB
Power Range	-60 dBm to +15 dBm
Power Accuracy	±1.5 dB
Power Resolution	0.050 dB
Harmonic distortion (Power out 0 dBm)	-25 dBc
Non-harmonic spurious (Power out 0 dBm)	-30 dBc

Test Port Input

Match (without system error correction)	
100 kHz to 1 MHz	12 dB
1 MHz to 9 GHz	20 dB
Damage Level	+26 dBm
Damage DC Voltage	35 V
Noise Floor	
100 kHz to 1 MHz	-100 dBm/Hz
1 MHz to 8 GHz	-143 dBm/Hz
8 GHz to 9 GHz	-133 dBm/Hz

Measurement Speed

Number of points (IF bandwidth 1 MHz)	Uncorrected	2-Port Calibration
51	1.0 ms	2.0 ms
201	2.6 ms	5.0 ms
401	4.6 ms	9.0 ms
1601	16.7 ms	33.3 ms

External Reference Input

Connector type	BNC Female
External reference frequency	10 MHz
Input level	-2 dBm to 4 dBm
Input impedance at <<Ref IN 10 MHz>>	50 Ohm

External Reference Output

<<OUT 10 MHz>> connector type	BNC Female
Output reference signal level at 50 Ohm impedance	0 dBm to 2 dBm

External Trigger Input

Type	BNC, Female
Input level low threshold voltage	0.8 V
Input level high threshold voltage	2.7 V
Input level range	0 to 5 V
Pulse width	2 µsec
Polarity	Positive or Negative

External Trigger Output

Type	BNC, Female
Maximum output current	20 mA
Output level low threshold voltage	0.4 V
Output level high threshold voltage	3.0 V
Polarity	Positive or Negative

System & Power

Operating temperature	5°C to 40°C (41°F to 104°F)
Storage temperature	-50°C to 70°C (-58°F to 158°F)
Humidity	90% at 25°C (77°F)
Atmospheric pressure	84.0 kPa to 106.7 kPa
Power Supply	110-240 V, 50-60 Hz
Power Consumption	75.0 W
Weight	10 kg/353 oz

Factory Adjustment

Recommended Factory Adjustment Interval	3 Years
------------------------------------------------	---------

C2409 Specifications¹

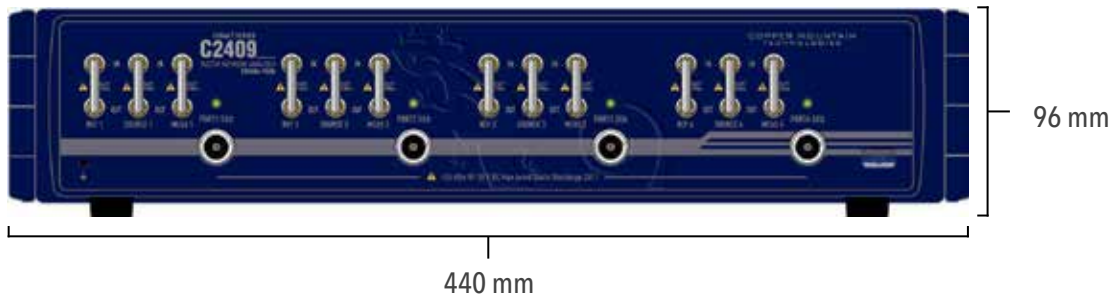

Primary Specifications

Impedance	50 Ohm
Test port connector	N-type Female
Number of test ports	4
Direct access	Yes; Source, Ref, and Meas
Frequency range	100 kHz to 9.0 GHz
Full CW Frequency	$\pm 2 \times 10^6$
Frequency setting resolution	1 Hz
Number of measurement points	2 to 500,001
Measurement bandwidths with 1/1.5/2/3/5/7 steps	1 Hz to 2 MHz
Dynamic range	
100 kHz to 1 MHz; 1 Hz IF BW	115 dB
1 MHz to 8 GHz; 1 Hz IF BW	158 dB/162 dB, typ.
8 GHz to 9 GHz; 1 Hz IF BW	148 dB/152 dB, typ.
Time per point (Typ.)	10 μ sec
Port switchover time (Typ.)	0.2 msec

Effective System Data

Effective directivity	46 dB
Effective source match	40 dB
Effective load match	46 dB

Measurement Accuracy

Transmission ²	(Magnitude/Phase)
100 kHz to 1 MHz	
5 dB to 15 dB	0.2 dB/2°
-30 dB to 5 dB	0.1 dB/1°
-50 dB to -30 dB	0.2 dB/2°
-70 dB to -50 dB	1.0 dB/6°
1 MHz to 8 GHz	
5 dB to 15 dB	0.2 dB/2°
-70 dB to 5 dB	0.1 dB/1°
-90 dB to -70 dB	0.2 dB/2°
-110 dB to -90 dB	1.0 dB/6°
8 GHz to 9 GHz	
5 dB to 15 dB	0.2 dB/2°
-60 dB to 5 dB	0.1 dB/1°
-80 dB to -60 dB	0.2 dB/2°
-100 dB to -80 dB	1.0 dB/6°
Reflection	(Magnitude/Phase)
-15 dB to 0 dB	0.4 dB/3°
-25 dB to -15 dB	1.0 dB/6°
-35 dB to -25 dB	3.0 dB/20°
Trace noise magnitude (3 kHz IF BW)	
100 kHz to 1 MHz	0.005 dB RMS
1 MHz to 9 GHz	0.001 dB RMS
Temperature dependence	0.020 dB/°C, 0.010 dB/°C typ.

Schematic Diagram of Cobalt C2409

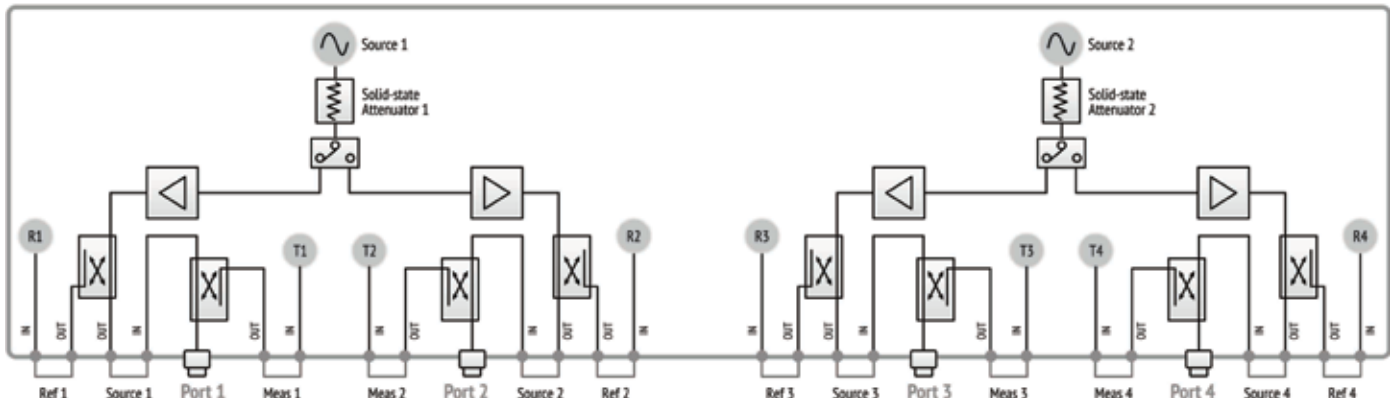

[1] All specifications subject to change without notice.

[2] At 23 °C +/- 5 °C after warmup time, with +/- 1°C ambient deviation from calibration temperature, at high output power

© Copper Mountain Technologies - www.coppermountaintech.com - Rev. 2017Q2

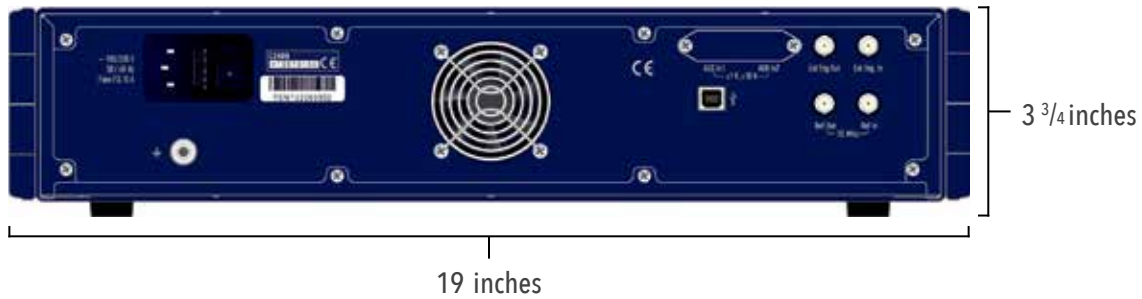

Test Port

Directivity (without system error correction)	
100 kHz to 1 MHz	12 dB
1 MHz to 9 GHz	15 dB

Test Port Output

Match (without system error correction)	
100 kHz to 1 MHz	12 dB
1 MHz to 9 GHz	15 dB
Power Range	-60 dBm to +15 dBm
Power Accuracy	±1.5 dB
Power Resolution	0.050 dB
Harmonic distortion (Power out 0 dBm)	-25 dBc
Non-harmonic spurious (Power out 0 dBm)	-30 dBc

Test Port Input

Match (without system error correction)	
100 kHz to 1 MHz	12 dB
1 MHz to 9 GHz	15 dB
Damage Level	+26 dBm
Damage DC Voltage	35 V
Noise Floor	
100 kHz to 1 MHz	-100 dBm/Hz
1 MHz to 8 GHz	-143 dBm/Hz
8 GHz to 9 GHz	-133 dBm/Hz

Measurement Speed

Number of points (IF bandwidth 1 MHz)	Uncorrected	2-Port Calibration
51	1.0 ms	2.0 ms
201	2.6 ms	5.0 ms
401	4.6 ms	9.0 ms
1601	16.7 ms	33.3 ms

External Reference Input

Connector type	BNC Female
External reference frequency	10 MHz
Input level	-2 dBm to 4 dBm
Input impedance at <<Ref IN 10 MHz>>	50 Ohm

External Reference Output

<<OUT 10 MHz>> connector type	BNC Female
Output reference signal level at 50 Ohm impedance	0 dBm to 2 dBm

External Trigger Input

Type	BNC, Female
Input level low threshold voltage	0.8 V
Input level high threshold voltage	2.7 V
Input level range	0 to 5 V
Pulse width	2 µsec
Polarity	Positive or Negative

External Trigger Output

Type	BNC, Female
Maximum output current	20 mA
Output level low threshold voltage	0.4 V
Output level high threshold voltage	3.0 V
Polarity	Positive or Negative

System & Power

Operating temperature	5°C to 40°C (41°F to 104°F)
Storage temperature	-50°C to 70°C (-58°F to 158°F)
Humidity	90% at 25°C (77°F)
Atmospheric pressure	84.0 kPa to 106.7 kPa
Power Supply	110-240 V, 50-60 Hz
Power Consumption	75.0 W
Weight	10.0 kg/353 oz

Factory Adjustment

Recommended Factory Adjustment Interval	3 Years
------------------------------------------------	---------

Direct Receiver Access Ports

Maximum input, Ref 1&2	-3 dBm
Maximum input, Source 1&2	15 dBm
Maximum input, Meas 1&2	-3 dBm
Damage level, Ref 1&2	13 dBm
Damage level, Source 1&2	26 dBm
Damage level, Meas 1&2	13 dBm
Damage DC voltage, Ref 1&2	0 V DC
Damage DC voltage, Source 1&2	35 V DC
Damage DC voltage, Meas 1&2	0 V DC

C4409 Specifications¹

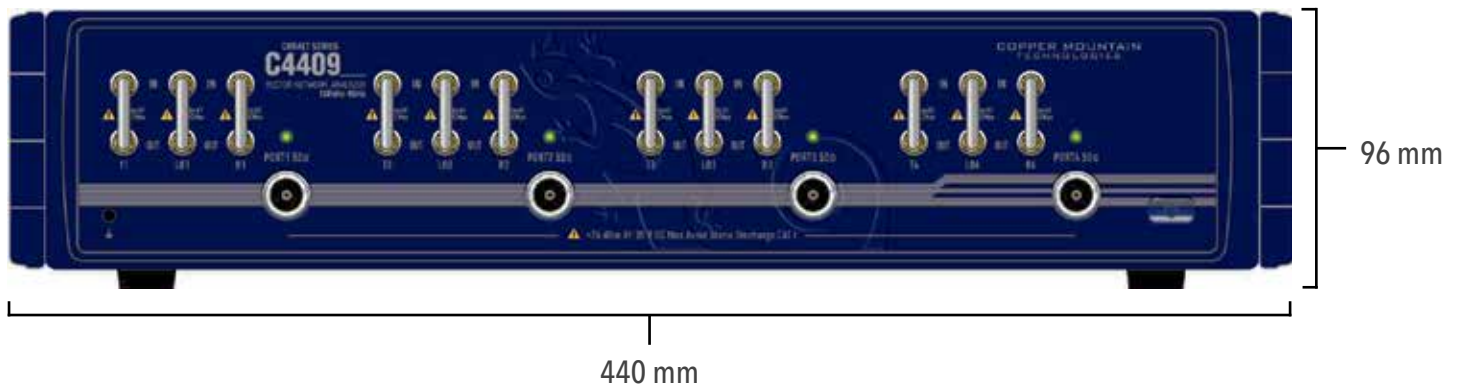

Primary Specifications

Impedance	50 Ohm
Test port connector	N-type Female
Number of test ports	4
Frequency extender compatible	Yes; CobaltFx (4 ports)
Frequency range	100 kHz to 9.0 GHz
Full CW Frequency	$\pm 2 \times 10^6$
Frequency setting resolution	1 Hz
Number of measurement points	2 to 500,001
Measurement bandwidths with 1/1.5/2/3/5/7 steps	1 Hz to 2 MHz
Dynamic range	
100 kHz to 1 MHz; 1 Hz IF BW	115 dB
1 MHz to 8 GHz; 1 Hz IF BW	158 dB/162 dB, typ.
8 GHz to 9 GHz; 1 Hz IF BW	148 dB/152 dB, typ.
Time per point (Typ.)	10 μ sec
Port switchover time (Typ.)	0.2 msec

Measurement Accuracy

Transmission ²	(Magnitude/Phase)
100 kHz to 1 MHz	
5 dB to 15 dB	0.2 dB/2°
-30 dB to 5 dB	0.1 dB/1°
-50 dB to -30 dB	0.2 dB/2°
-70 dB to -50 dB	1.0 dB/6°
1 MHz to 8 GHz	
5 dB to 15 dB	0.2 dB/2°
-70 dB to 5 dB	0.1 dB/1°
-90 dB to -70 dB	0.2 dB/2°
-110 dB to -90 dB	1.0 dB/6°
8 GHz to 9 GHz	
5 dB to 15 dB	0.2 dB/2°
-60 dB to 5 dB	0.1 dB/1°
-80 dB to -60 dB	0.2 dB/2°
-100 dB to -80 dB	1.0 dB/6°
Reflection	
	(Magnitude/Phase)
-15 dB to 0 dB	0.4 dB/3°
-25 dB to -15 dB	1.0 dB/6°
-35 dB to -25 dB	3.0 dB/20°
Trace noise magnitude (3 kHz IF BW)	
100 kHz to 1 MHz	0.005 dB RMS
1 MHz to 9 GHz	0.001 dB RMS
Temperature dependence	0.020 dB/°C, 0.010 dB/°C typ.

Effective System Data

Effective directivity	46 dB
Effective source match	40 dB
Effective load match	46 dB

Test Port

Directivity (without system error correction)	
100 kHz to 1 MHz	12 dB
1 MHz to 9 GHz	18 dB

[1] All specifications subject to change without notice.

[2] At 23 °C +/- 5 °C after warmup time, with +/- 1°C ambient deviation from calibration temperature, at high output power

© Copper Mountain Technologies - www.coppermountaintech.com - Rev. 2017Q2

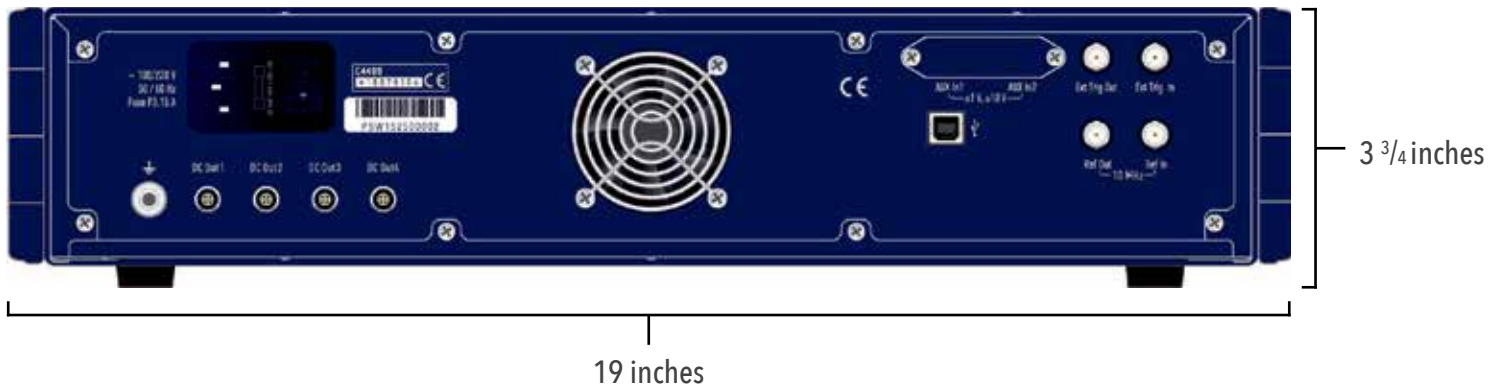

Test Port Output

Match (without system error correction)	
100 kHz to 1 MHz	12 dB
1 MHz to 9 GHz	20 dB
Power Range	-60 dBm to +15 dBm
Power Accuracy	±1.5 dB
Power Resolution	0.050 dB
Harmonic distortion (Power out 0 dBm)	-25 dBc
Non-harmonic spurious (Power out 0 dBm)	-30 dBc

Test Port Input

Match (without system error correction)	
100 kHz to 1 MHz	12 dB
1 MHz to 9 GHz	20 dB
Damage Level	+26 dBm
Damage DC Voltage	35 V
Noise Floor	
100 kHz to 1 MHz	-100 dBm/Hz
1 MHz to 8 GHz	-143 dBm/Hz
8 GHz to 9 GHz	-133 dBm/Hz

Measurement Speed

Number of points (IF bandwidth 1 MHz)	Uncorrected	2-Port Calibration
51	1.0 ms	2.0 ms
201	2.6 ms	5.0 ms
401	4.6 ms	9.0 ms
1601	16.7 ms	33.3 ms

External Reference Input

Connector type	BNC Female
External reference frequency	10 MHz
Input level	-2 dBm to 4 dBm
Input impedance at <<Ref IN 10 MHz>>	50 Ohm

External Reference Output

<<OUT 10 MHz>> connector type	BNC Female
Output reference signal level at 50 Ohm impedance	0 dBm to 2 dBm

External Trigger Input

Type	BNC, Female
Input level low threshold voltage	0.8 V
Input level high threshold voltage	2.7 V
Input level range	0 to 5 V
Pulse width	2 µsec
Polarity	Positive or Negative

External Trigger Output

Type	BNC, Female
Maximum output current	20 mA
Output level low threshold voltage	0.4 V
Output level high threshold voltage	3.0 V
Polarity	Positive or Negative

System & Power

Operating temperature	5°C to 40°C (41°F to 104°F)
Storage temperature	-50°C to 70°C (-58°F to 158°F)
Humidity	90% at 25°C (77°F)
Atmospheric pressure	84.0 kPa to 106.7 kPa
Power Supply	110-240 V, 50-60 Hz
Power Consumption	145.0 W
Weight	10 kg/353 oz

Factory Adjustment

Recommended Factory Adjustment Interval	3 Years
------------------------------------------------	---------

Technology is supposed to move. It's supposed to change and update and progress. It's not meant to sit stagnant year after year simply because that's how things have always been done.

The engineers at Copper Mountain Technologies are creative problem solvers. They know the people using VNAs don't just need one giant machine in a lab. They know that VNAs are needed in the field, requiring portability and flexibility. Data needs to be quickly transferred, and a test setup needs to be easily automated and recalled for various applications. The engineers at Copper Mountain Technologies are rethinking the way VNAs are developed and used.

Copper Mountain Technologies' VNAs are designed to work with the Windows PC you already use via USB interface. After installing the test software, you have a top-quality VNA at a fraction of the cost of a traditional analyzer. The result is a faster, more effective test process that fits into the modern workspace. This is the creativity that makes Copper Mountain Technologies stand out above the crowd.

We're creative. We're problem solvers.

631 E. New York St | Indianapolis, IN | 46202
www.coppermountaintech.com

USA: +1.317.222.5400
Singapore: +65.6323.6546

	C1209	C2209	C4209	C1409	C2409	C4409
Frequency Range	100 kHz to 9 GHz	100 kHz to 9 GHz	100 kHz to 9 GHz	100 kHz to 9 GHz	100 kHz to 9 GHz	100 kHz to 9 GHz
Number of Ports	2	2	2	4	4	4
Additional Features		Direct Receiver Access	Frequency Extension		Direct Receiver Access	Frequency Extension